

Slope Glaze

H1
H2
H3

Elevation
Half Size Details
Price Sheet



www.CAPinc.biz

Fax 303.761.5722 / Phone 303.761.5452
2950 S. Wyandot St. Englewood CO 80110



SLOPE GLAZE SYSTEMS

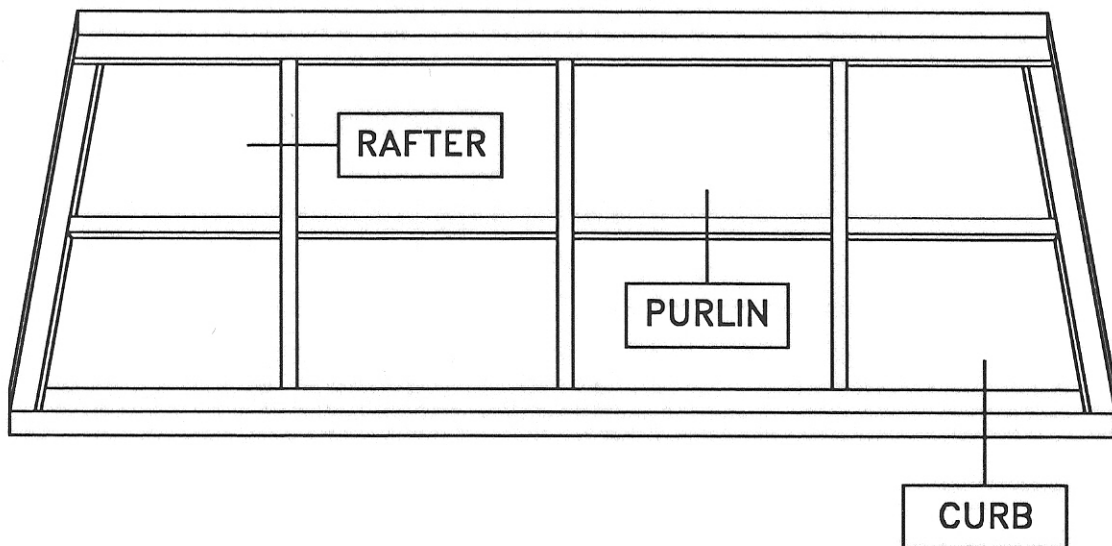

TYPICAL ELEVATION



Half Size Details

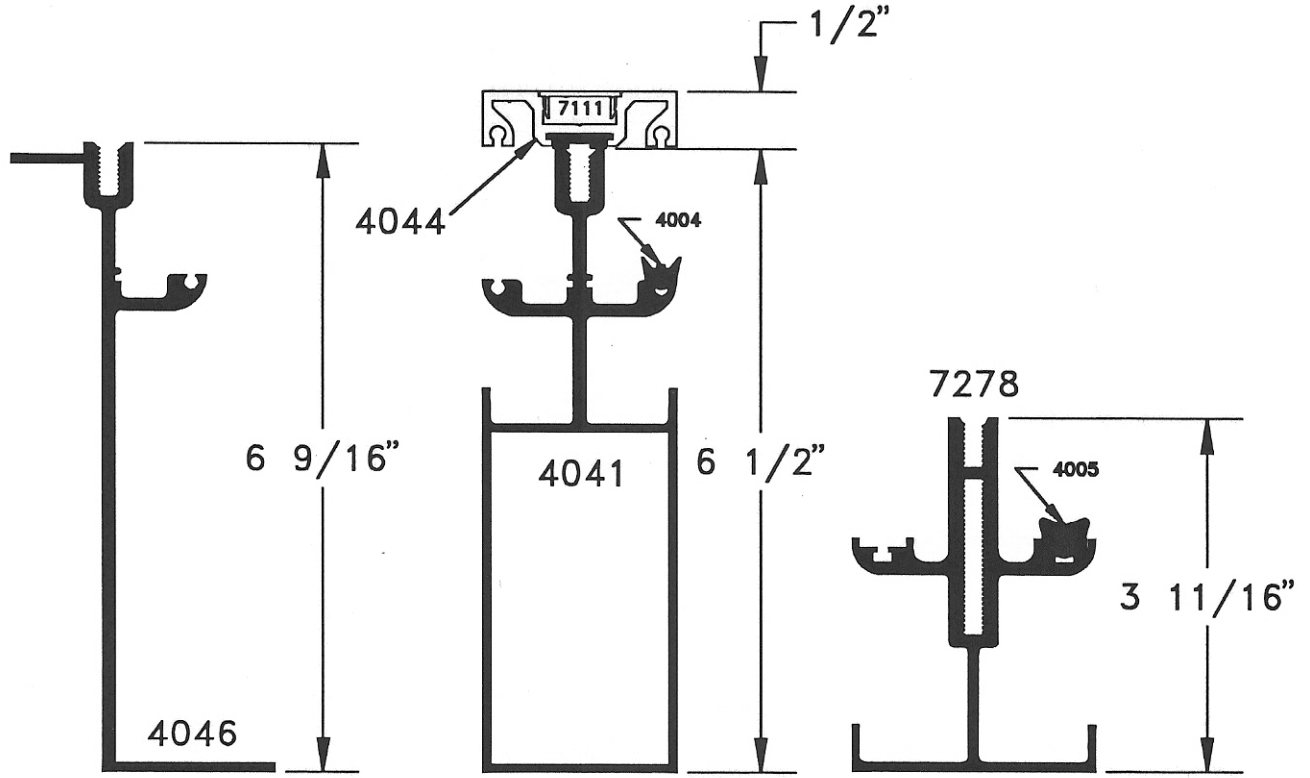

GUTTER

RAFTER

PURLIN/RAFTER

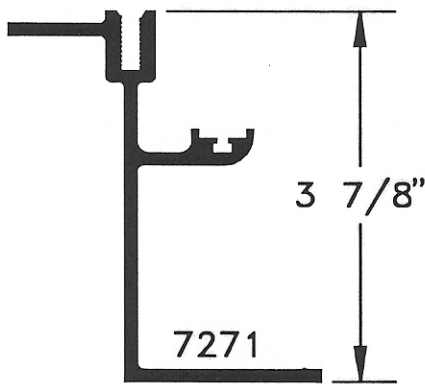

GUTTER

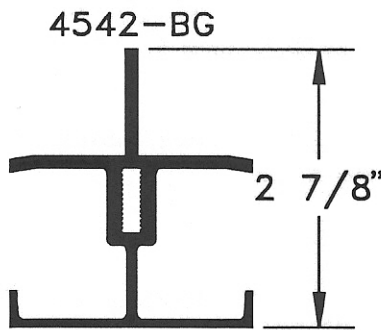

PURLIN

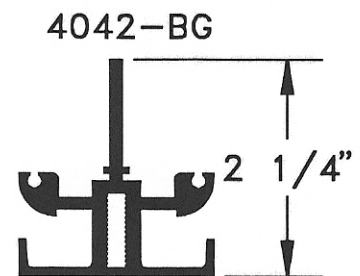

PURLIN









***Note: System is Special Order
Minimum Quantities Req'd

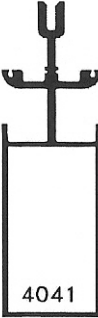
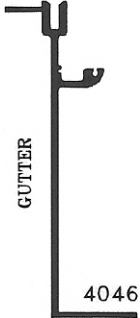
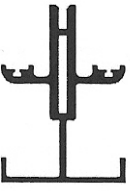

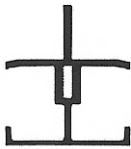
CALL FOR QUOTE

OTHER RELATED SECTIONS AVAILABLE

Phone: 303.761.5452 / Fax 303.761.5722

	 <p>RAFTER</p> <p>4041</p>	 <p>GUTTER</p> <p>4046</p>	<p>RAFTER / PURLIN</p>  <p>7278</p>	<p>GUTTER</p>  <p>7271</p>
PART NUMBER				
STOCK LENGTH	24'	24'	24'	24'
CLEAR				
BRONZE				
	<p>PURLIN</p>  <p>4542-BG</p>	<p>PURLIN</p>  <p>4042-BG</p>	<p>PRESSURE PLATE</p>  <p>4044</p>	<p>FACE COVER</p>  <p>7111</p>
PART NUMBER				
STOCK LENGTH	24'	24'	24'	24'
CLEAR				
BRONZE				
	<p>ISOLATER</p>  <p>4001</p>	<p>GASKET</p>  <p>4005</p>		
PART NUMBER				
STOCK LENGTH				
CLEAR				
BRONZE				